











PEGAS



510x510 HERKULES X-S

 mm	 mm	 $\frac{b}{a}$ a x b	 $\frac{b}{a}$ a x b
510	510	500×720	500×450

	 kW	 m/min	 mm	 kg
3×400 V	7,5	15-80	6060×54×1,6	5020
L	B	Hmin	Hmax	V
3830	2450	2100	2600	830

*doporučené hodnoty/recommended values

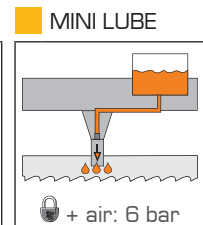
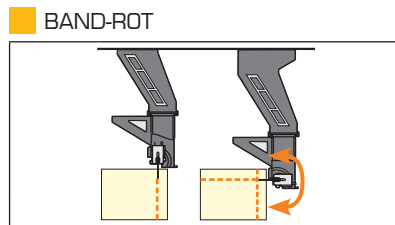
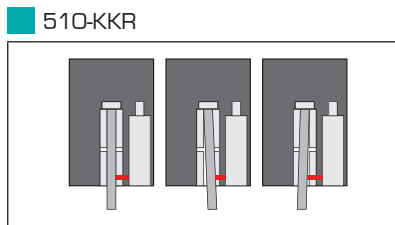
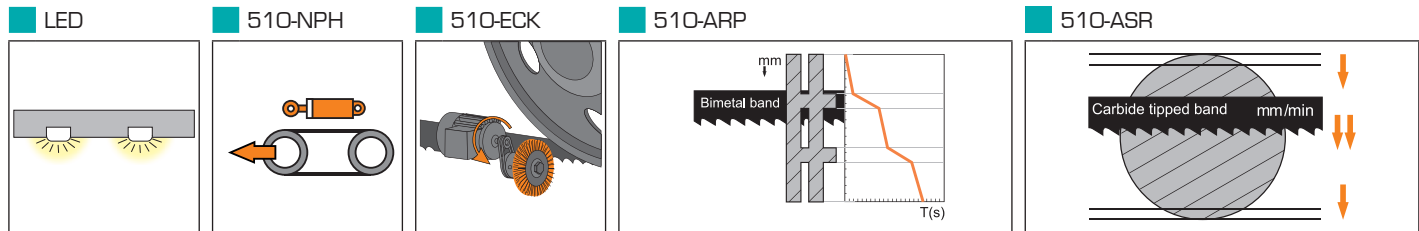

500 RDP 1000/620 +RBR



500-VTT

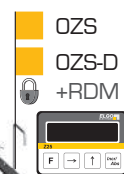
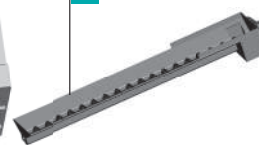

500 VZM

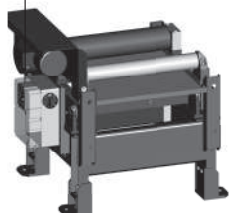

OZP-L
OZD-L

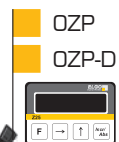

500 RDM 2000/620



500-V-TDT +TDT

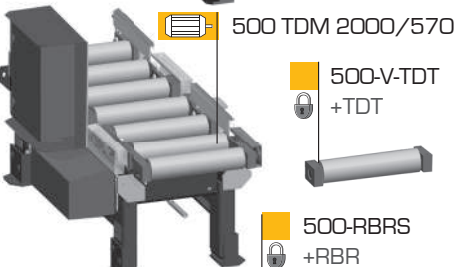

500-RBRS +RBR



500 RDT 2000/620



500-V +RDT



500-VN +RDT



500 RDT 1000/620

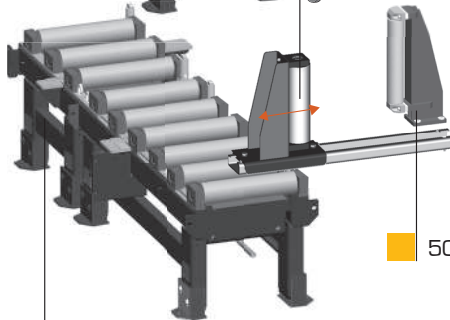

500-TDT-RBR

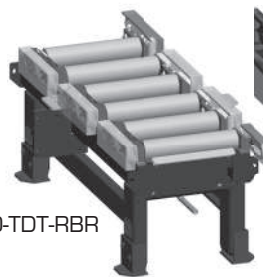

500 RDML 1000/620
500 RDML 2000/620



500 OZK

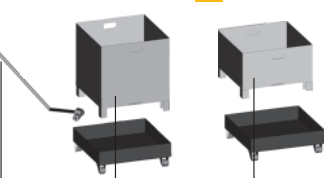

BOX-TAH

BOX-PCS

BOX-TRI

510x510 HERKULES X-S

STANDARD OPTION



-Россия, 614014, г. Пермь, ул. 1905 года, 35 корп. 1
Общий тел/факс: (342) 215-45-18;
Отдел оборудования: доб.191, 192, 195, 197, 199.
E-mail: info@uipumori.ru
www.uipumori.ru

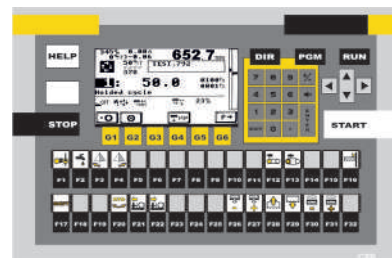

CONTROL PANEL: MAHLER (X)